

TECH LED

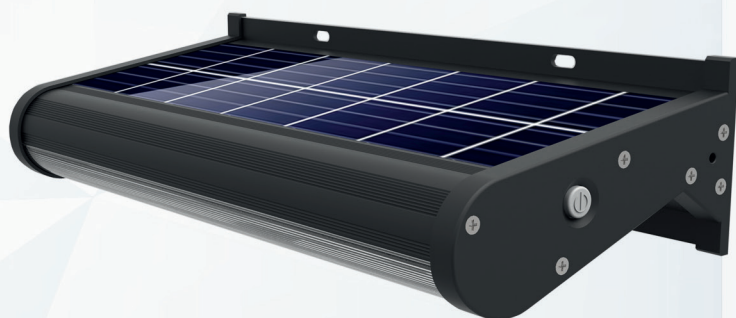

CATALOGUE 2019 - 2020

SOMMAIRE

ÉCLAIRAGE D'INTÉRIEUR

Plafonniers puits de lumière	p.2
------------------------------	-----

CASQUETTES, APPLIQUES, SPOT SOL SOLAIRE ET BATTERIES

Appliques casquettes solaires	p.5
Spot solaire encastrable sol	p.5
Appliques murales solaires	p.6
Batterie pour appliques solaires	p.7
Présentoir appliques solaires	p.7

PROFILÉS ET TERMINAISONS POUR BANDES LED

Profilés LED fin-8	p.9
Profilés LED fin-10	p.9
Profilés LED plat-10	p.9
Profilés LED plat-14	p.9
Profilés LED large-24	p.10
Profilés LED reflex-8	p.10
Profilés LED href-8	p.10
Profilés LED profond-10	p.11
Profilés LED rainure-10	p.11
Profilés LED sol-12	p.11
Profilés LED rainure-14	p.11
Profilés LED angle 45°-10	p.12
Profilés LED angle 30/60°-10	p.12
Profilés LED angle 30/60°-14	p.12
Profilés LED tube-8	p.12
Profilés LED arrière-10	p.13
Profilés LED marche-10	p.13
Profilés LED courbe-12	p.13
Profilés LED mur-12	p.14
Profilés LED ovale-20	p.14
Profilés LED glass-10	p.14
Profilés LED bord-10	p.15
Profilés LED glass line-12	p.15

DIFFUSEURS, SUPPORTS, CONNECTEURS ET BANDES LED

DIFFUSEURS

Diffuseurs Plat	p.17
Diffuseurs Clip Arc	p.17
Diffuseurs Reflex	p.18
Diffuseurs Sol	p.18
Diffuseurs Clip	p.18
Diffuseurs Lentille	p.18
Diffuseurs Tubes	p.18

SUPPORTS PROFILÉS LED

p.19

CONNECTEURS ANGLES

p.19

BANDES LED

p.20

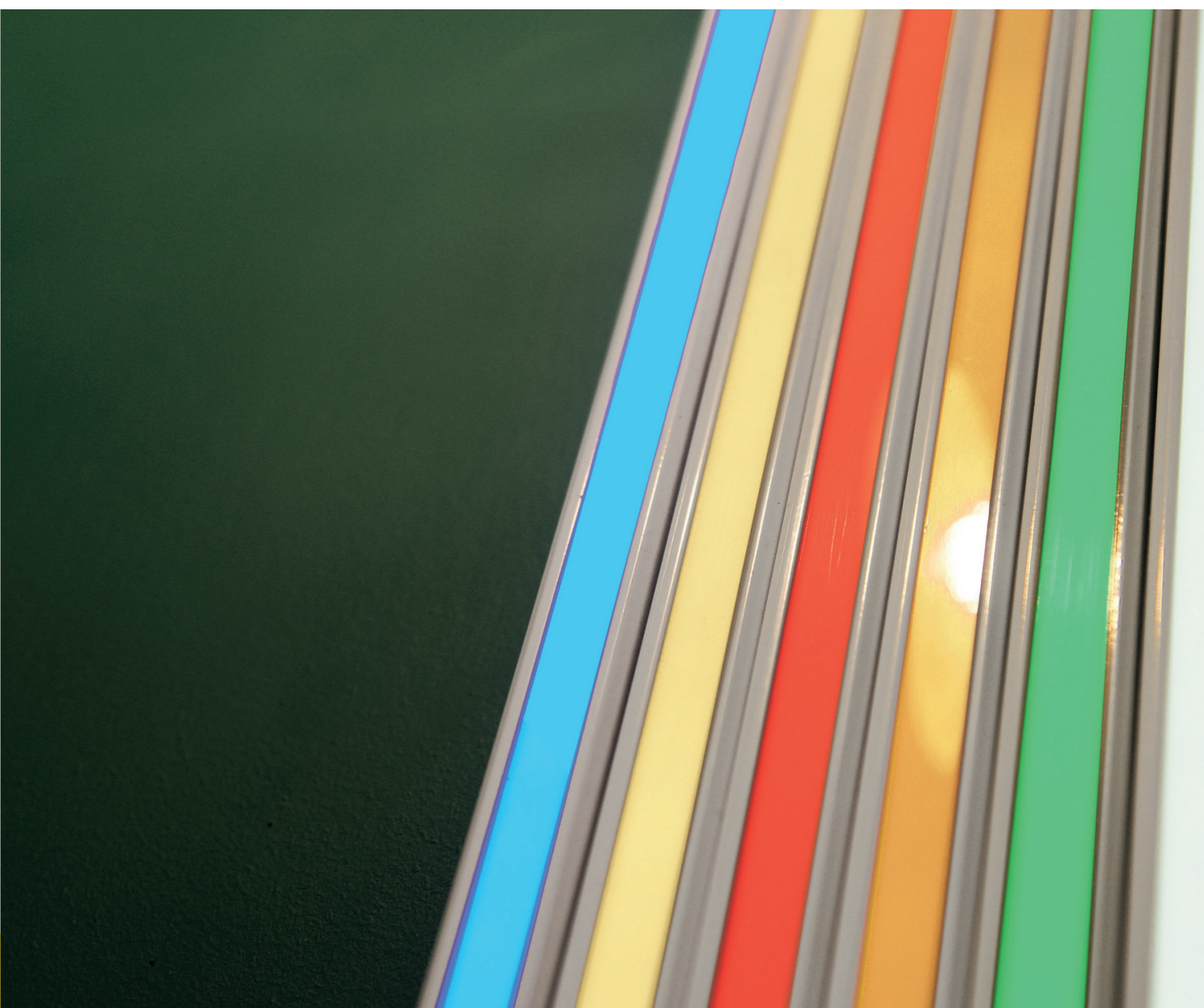

Éclairage d'intérieur



PLAFONNIERS Puits DE LUMIERE - TECHLED



REF	PUISSANCE	ANGLE	DIMENSIONS	IP
P992000A	38W	160	595x595x13	20
P992000B	38W	160	595x595x13	20
P992000C	38W	160	595x595x13	20
P992000D	38W	160	595x595x13	20
P992000	38w (x4 dalles)	160	1200x1200x13	20



REF	PUISSANCE	ANGLE	DIMENSIONS	IP
P992001	38W	160	595x595x13	20
P992002				
P992003				

DALLE (LETTRE)	REF
A	Ref+A
B	Ref+B
C	Ref+C
D	Ref+D
E	Ref+E
F	Ref+F
G	Ref+G
H	Ref+H
I	Ref+I

EXEMPLES :
 Commande de la ref. P992004, dalles A, E et I : P992004A / P992004E / P992004I
 Commande de la ref. P992011, dalles B, C, D : P992011B / P992011C / P992011D

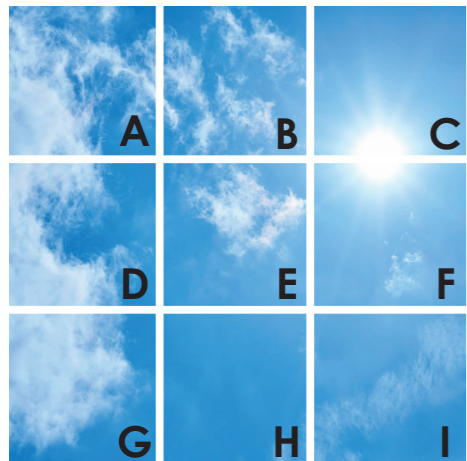

P992004

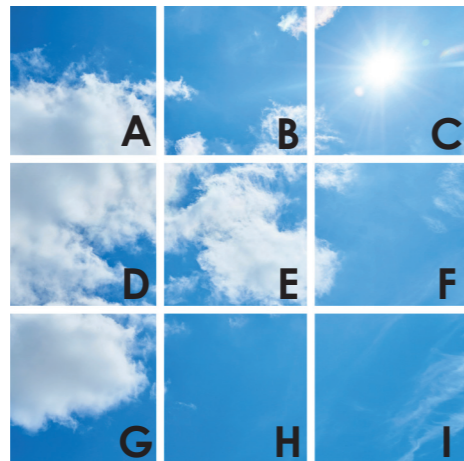

P992005



P992006

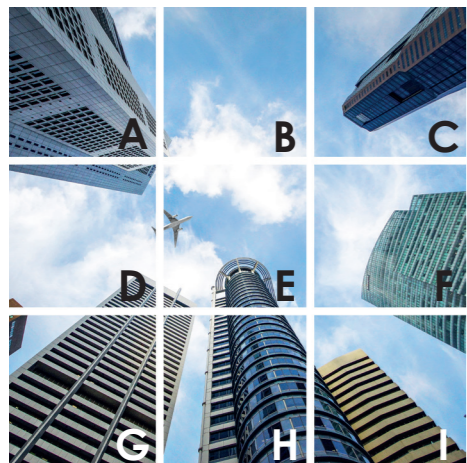

P992007



P992008



P992009



P992010

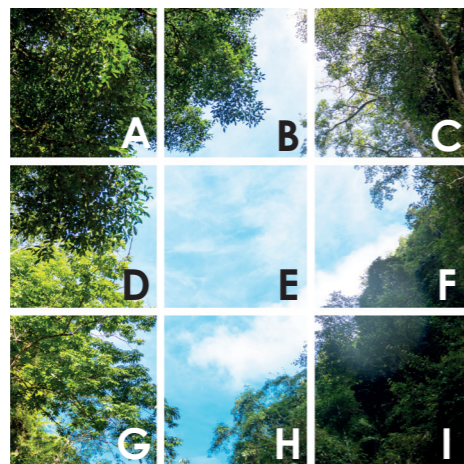

P992011

DALLE (LETTRE)	REF
A	Ref+A
B	Ref+B
C	Ref+C
D	Ref+D
E	Ref+E
F	Ref+F
G	Ref+G
H	Ref+H
I	Ref+I

REF	PUISSANCE	ANGLE	DIMENSIONS	IP
P992004	38W	160	595x595x13	20
P992005				
P992006				
P992007				

REF	PUISSANCE	ANGLE	DIMENSIONS	IP
P992008	38W	160	595x595x13	20
P992009				
P992010				
P992011				

EXEMPLES :
 Commande de la ref. P992004, dalles A, E et I : P992004A / P992004E / P992004I
 Commande de la ref. P992011, dalles B, C, D : P992011B / P992011C / P992011D

Casquettes, appliques, spot sol solaire et batteries

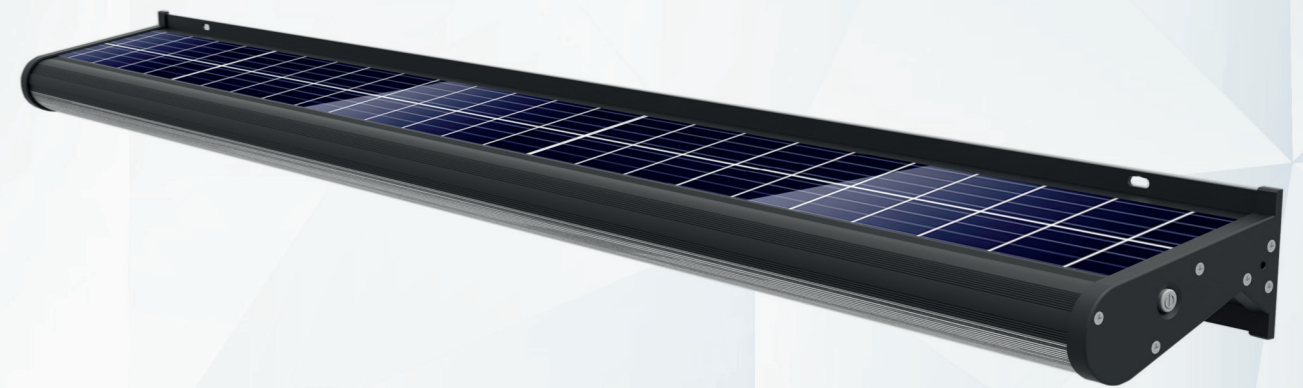

APPLIQUES CASQUETTES SOLAIRES - TECHLED

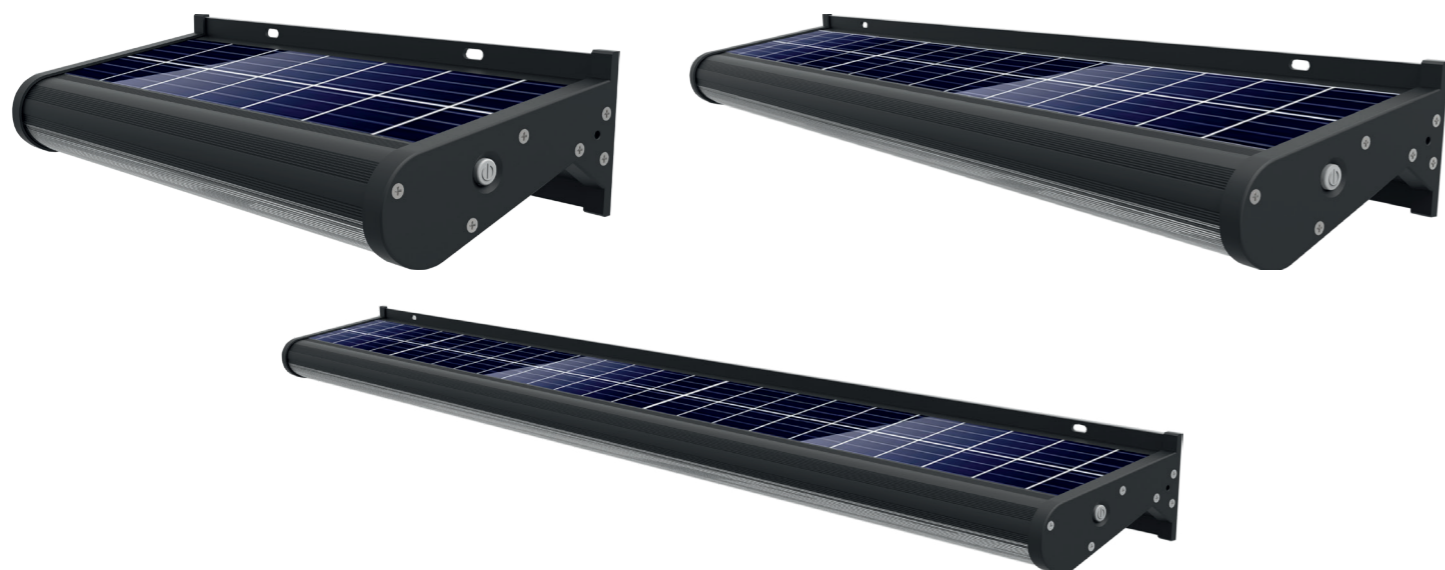

REF	PUISSANCE	T° COULEUR	LUMENS	DIMENSIONS	IP
P99100	5W	6000°K	500	Longueur : 30cm	65
P99101	10W		1000	Longueur : 60cm	
P99102	20W		2000	Longueur : 105cm	

SPOT SOLAIRE ENCASTRABLE SOL - TECHLED



REF	PUISSANCE	T° COULEUR	LUMENS	DIMENSIONS	IP
P99103	0.5W	6000K + bleu	50	Ø170mm - Profondeur 55mm	68

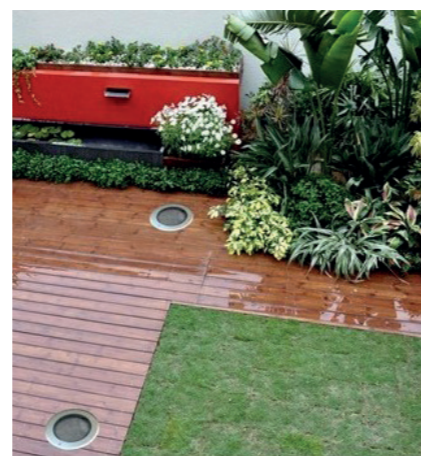
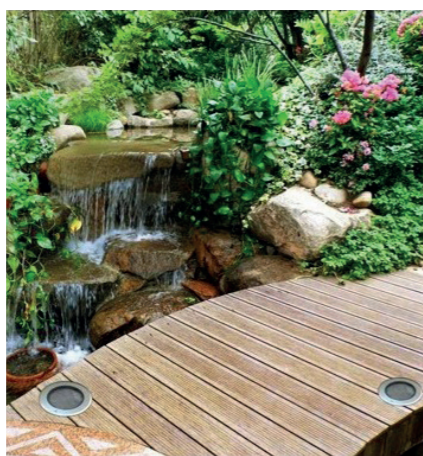
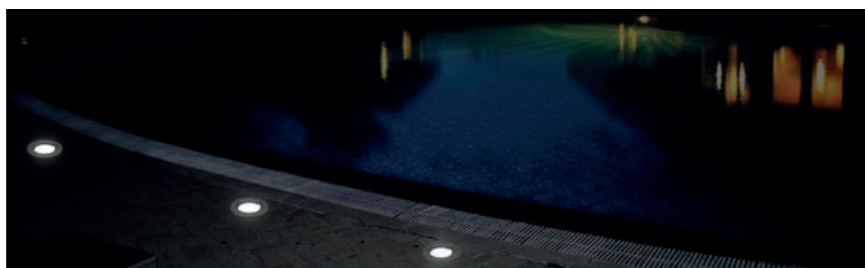

APPLIQUES MURALES SOLAIRES - TECHLED

Appliques murales solaires LED - 1,5W - modèle CURVE



REF	P. ABSORBÉE	T° COULEUR	LUMENS	DIMENSIONS	IP	FINITION
P99012	1,5W	6000°K/3000°K	200	152x96x83,4mm	65	NOIR
P99011						BLANC
P99013						ARGENT

Applique murale solaire LED - 2W - modèle CURVE



REF	P. ABSORBÉE	T° COULEUR	LUMENS	DIMENSIONS	IP	FINITION
P99017	2W	6000°K/3000°K	260	154,5x95x97,7mm	65	BLANC

Appliques murales solaires LED - 3,2W - modèle CURVE



REF	P. ABSORBÉE	T° COULEUR	LUMENS	DIMENSIONS	IP	FINITION
P99015	3,2W	6000°K/3000°K	400	214x140x109,2mm	65	NOIR
P99014				215x140x109,2mm		BLANC
P99016				216x140x109,2mm		ARGENT

Applique murale solaire LED - 6,8W - modèle CURVE

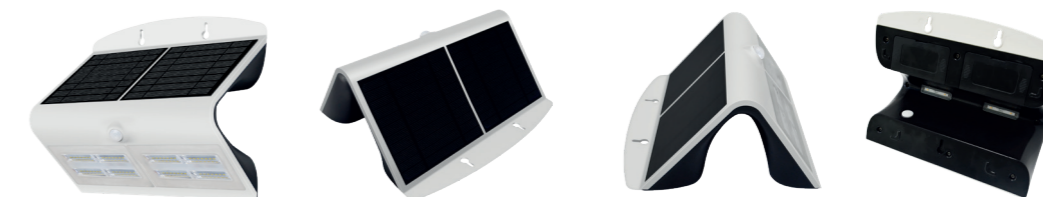

REF	P. ABSORBÉE	T° COULEUR	LUMENS	DIMENSIONS	IP	FINITION
P99019	6,8W	6000°K/3000°K	800	270x221x109,2mm	65	BLANC

Applique murale solaire LED - 2W - modèle CIRCLE



REF	P. ABSORBÉE	COULEUR	LUMENS	IP	FINITION	DIMENSIONS
P99018	2W	6000°K	200	65	ARGENT	158,5x152x123x5mm

BATTERIE APPLIQUES SOLAIRES - TECHLED



REF	CAPACITÉ	COMPATIBLE AVEC
P990001	1200 mAh	1,5W Curve - 2W Curve - 2W Crown
P990002	2000 mAh	3,2W Curve - 6,8W Curve (2 batteries)

PRÉSENTOIR APPLIQUES SOLAIRES - TECHLED



Deux appliques solaires incluses, possibilité d'en fixer une troisième sur le côté droit.

10 exemplaires du catalogue TECHLED inclus.

Dimensions :
 Longueur : 25cm
 Hauteur : 60cm
 Profondeur : 21,5cm

Profilés et terminaisons pour bandes LED

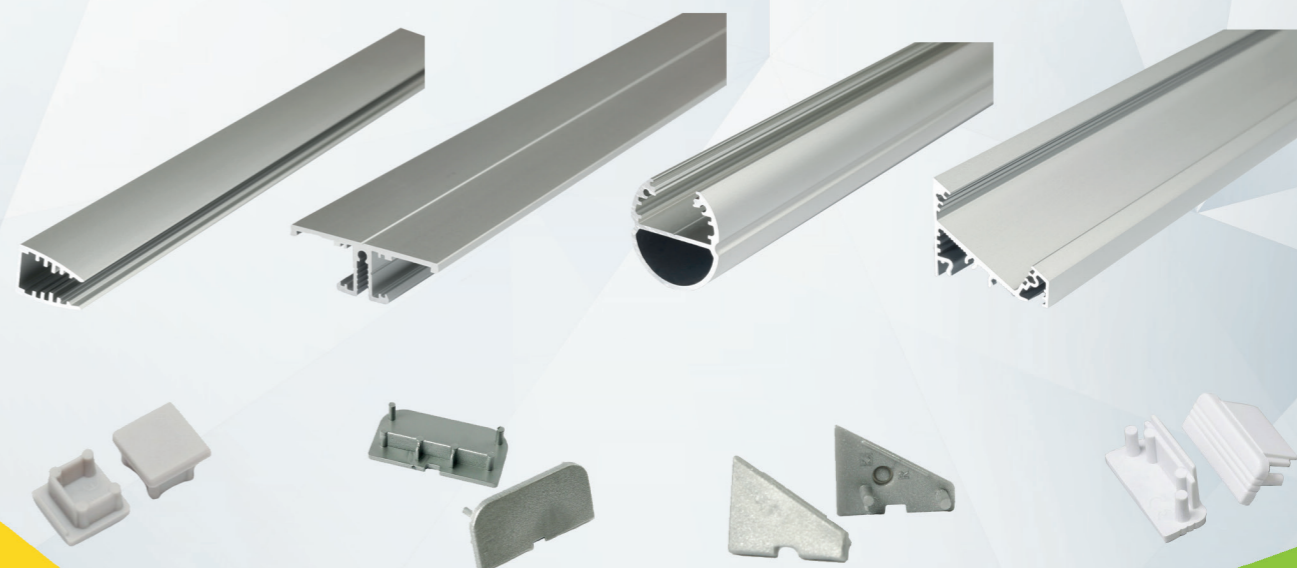
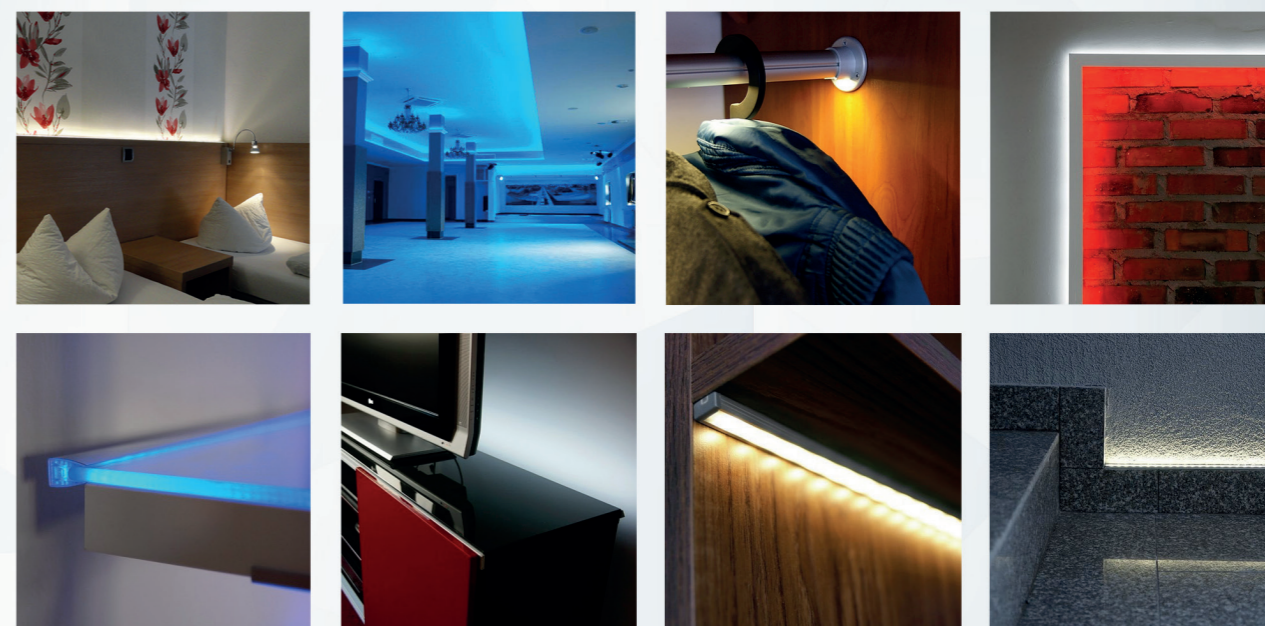

PROFILÉS LED FIN-8



Terminaison profilé LED fin-8 - Ref T98T101G

REF	TAILLE	FINITION	DIFFUSEUR ASSOCIÉ	FIXATION ASSOCIÉE
T98101R1	1000mm	Alu brut	A	Z
T98101R2	2000mm	Alu brut	A	Z
T98101A1	1000mm	Alu anodisé	A	Z
T98101A2	2000mm	Alu anodisé	A	Z

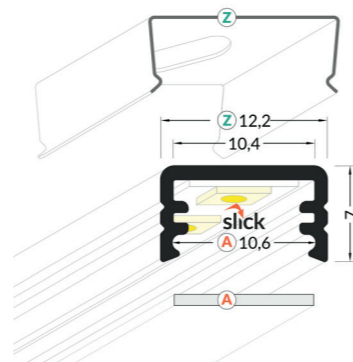

PROFILÉS LED LARGE-24

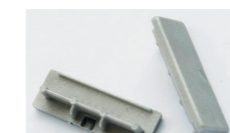
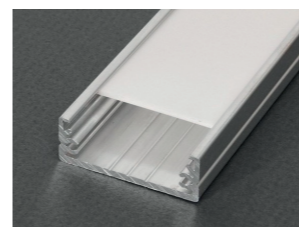

Terminaison profilé LED Large-24 - Ref T98T105G

REF	TAILLE	FINITION	DIFFUSEUR ASSOCIÉ	FIXATION ASSOCIÉE
T98105R1	1000mm	Alu brut	G	W
T98105R2	2000mm			
T98105A1	1000mm	Alu anodisé		
T98105A2	2000mm			

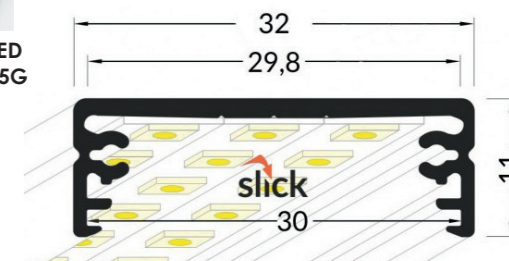

PROFILÉS LED FIN-10

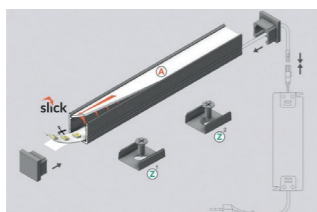

Terminaison profilé LED fin-10 - Ref T98T102G

REF	TAILLE	FINITION	LARGEUR MAX BANDE LED	DIFFUSEUR ASSOCIÉ	FIXATION ASSOCIÉE
T98102A1	1000mm	Alu anodisé	10 mm	A	Z
T98102A2	2000mm	Alu anodisé	10 mm	A	Z

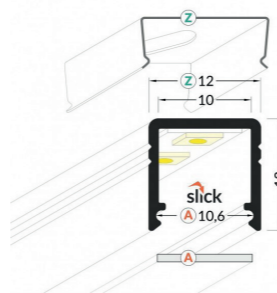

PROFILÉS LED REFLEX-8

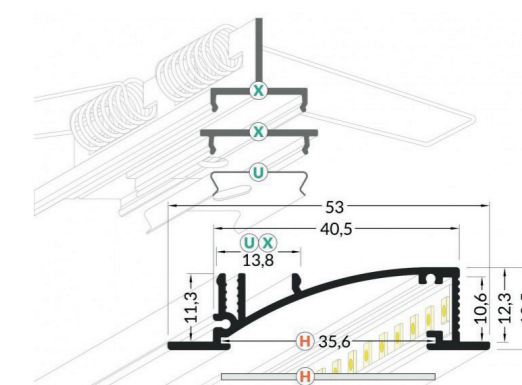
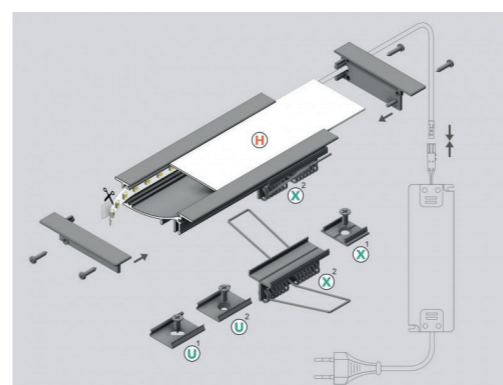

REF	TAILLE	FINITION	LARGEUR MAX BANDE LED	DIFFUSEUR ASSOCIÉ	FIXATION ASSOCIÉE
T98201B1	1000mm	Alu blanc	8 mm	H	U / X
T98201B2	2000mm				
T98201A1	1000mm	Alu anodisé			
T98201A2	2000mm				



Terminaison profilé LED reflex-8 - Ref T98T201G



Terminaison profilé LED reflex-8 - Ref T98T201B

PROFILÉS LED PLAT-10

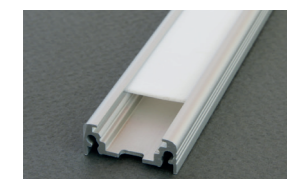

Terminaison profilé LED plat-10 gris - Ref T98T103G



Terminaison profilé LED plat-10 blanc - Ref T98T103B



Terminaison profilé LED plat-10 noir - Ref T98T103N

REF	TAILLE	FINITION	DIFFUSEUR ASSOCIÉ	FIXATION ASSOCIÉE
T98103R1	1000mm	Alu brut	B / C	U / X
T98103R2	2000mm			
T98103A1	1000mm	Alu anodisé		
T98103A2	2000mm			
T98103B1	1000mm	Blanc		
T98103B2	2000mm			
T98103N1	1000mm	Anodisé noir		
T98103N2	2000mm			

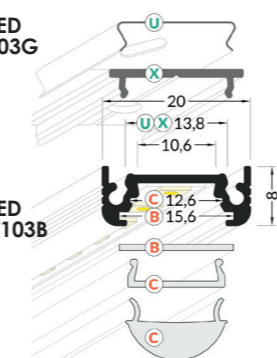

PROFILÉS LED PLAT-14

REF	TAILLE	FINITION	DIFFUSEUR ASSOCIÉ	FIXATION ASSOCIÉE
T98104R1	1000mm	Alu brut	E / F	T / Y
T98104R2	2000mm			
T98104A1	1000mm	Alu anodisé		
T98104A2	2000mm			



Terminaison profilé LED plat-14 Ref T98T104G

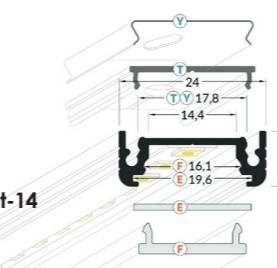

PROFILÉS LED HREF-8

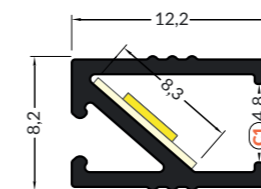

Terminaison profilé LED href-8 Gris : Ref T98T202G

REF	TAILLE	FINITION	LARGEUR MAX BANDE LED	DIFFUSEUR ASSOCIÉ
T98202A1	1000mm	Alu anodisé	8 mm	C1
T98202A2	2000mm			

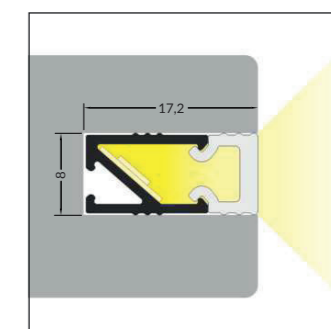

PROFILÉS LED PROFOND-10

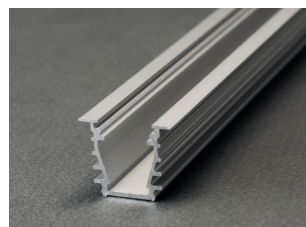

Terminaison profilé LED profond-10 - Ref T98T203G

REF	TAILLE	FINITION	DIFFUSEUR ASSOCIÉ	FIXATION ASSOCIÉE
T98203A1	1000mm	Alu anodisé	B / C	U / X
T98203A2	2000mm			

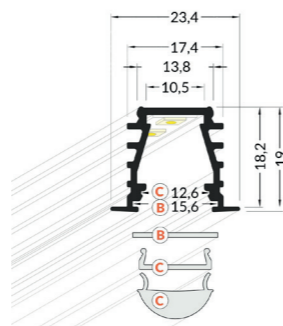

PROFILÉS LED ANGLE 45°-10



Terminaison profilé LED angle 45°-10 Ref T98T301G

REF	TAILLE	FINITION	DIFFUSEUR ASSOCIÉ	FIXATION ASSOCIÉE
T98301A1	1000mm	Alu anodisé	B / C	COLLE OU VIS
T98301A2	2000mm			
T98301R1	1000mm	Alu brut	B / C	COLLE OU VIS
T98301R2	2000mm			

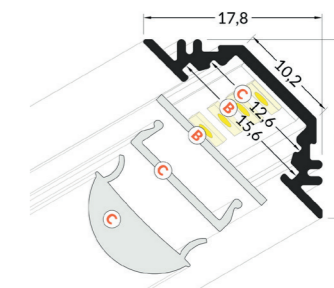

PROFILÉS LED RAINURE-10

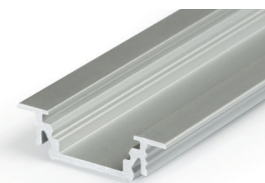
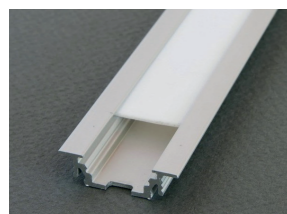

Terminaison profilé LED rainure-10 - Ref T98T204G

REF	TAILLE	FINITION	DIFFUSEUR ASSOCIÉ	FIXATION ASSOCIÉE
T98204R1	1000mm	Alu brut	B / C	U / X
T98204R2	2000mm			
T98204A1	1000mm	Alu anodisé	B / C	U / X
T98204A2	2000mm			

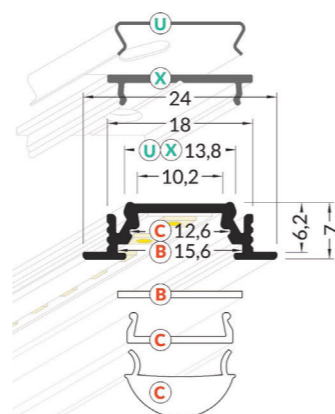

PROFILÉS LED ANGLE 30/60°-10

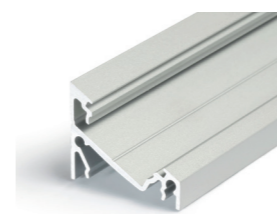
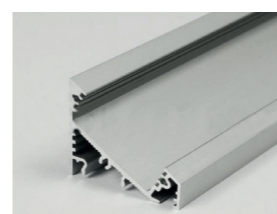

Terminaison profilé LED angle 30/60°-10 - Ref T98T302G

REF	TAILLE	FINITION	DIFFUSEUR ASSOCIÉ	FIXATION ASSOCIÉE
T98302A1	1000mm	Alu anodisé	B / C	U / X
T98302A2	2000mm			

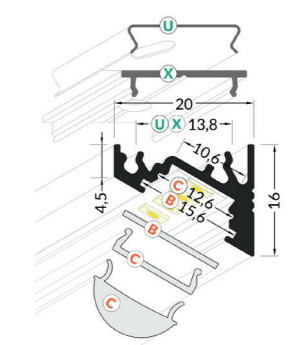

PROFILÉS LED SOL-12

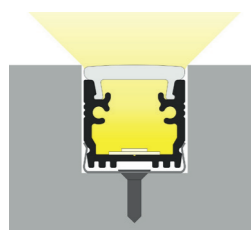

Terminaison profilé LED sol-12 Ref T98T206G

REF	TAILLE	FINITION	DIFFUSEUR ASSOCIÉ	FIXATION ASSOCIÉE
T98206A1	1000mm	Alu anodisé	K	U
T98206A2	2000mm			

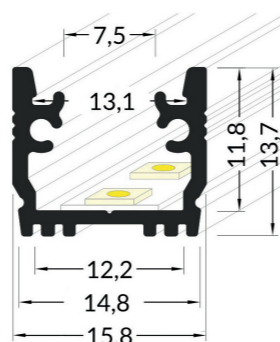

PROFILÉS LED ANGLE 30/60° - 14

REF	TAILLE	FINITION	DIFFUSEUR ASSOCIÉ	FIXATION ASSOCIÉE
T98303R1	1000mm	Alu brut	E / F	Y
T98303R2	2000mm			
T98303A1	2000mm	Alu anodisé	E / F	Y
T98303A2	2000mm			

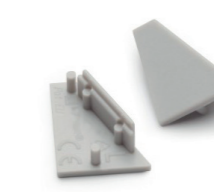

Terminaison profilé LED angle 30/60°-14 - Ref T98T303G

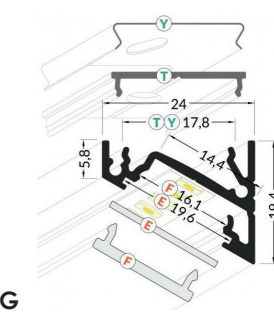

PROFILÉS LED RAINURE-14

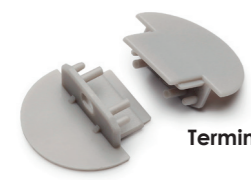

Terminaison profilé LED Rainure-14 Ref T98T205G

REF	TAILLE	FINITION	DIFFUSEUR ASSOCIÉ	FIXATION ASSOCIÉE
T98205R1	1000mm	Alu brut	E / F	T / Y
T98205R2	2000mm			
T98205A1	1000mm	Alu anodisé	E / F	T / Y
T98205A2	2000mm			

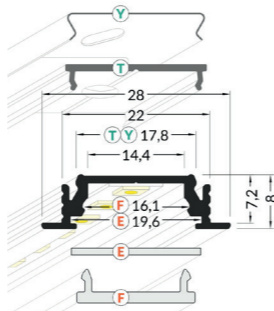
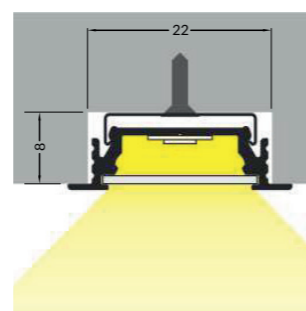

PROFILÉS LED TUBE-8

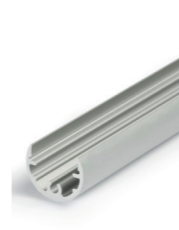

Support tube-8 profilé LED - Ref T98S0012

REF	TAILLE	FINITION	DIFFUSEUR ASSOCIÉ	FIXATION ASSOCIÉE
T98401A1	1000mm	Alu anodisé	I	Support profilés tube
T98401A2	2000mm			



Support Double 100mm avec cache profilé LED tube-8 - Ref T98S0013

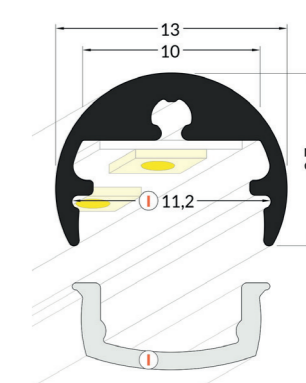

PROFILÉS LED ARRIÈRE-10



Terminaison profilé LED arrière-10 - Ref T98T402G

REF	TAILLE	FINITION	DIFFUSEUR ASSOCIÉ	FIXATION ASSOCIÉE
T98402A1	1000mm	Alu anodisé	A	U / X
T98402A2	2000mm			

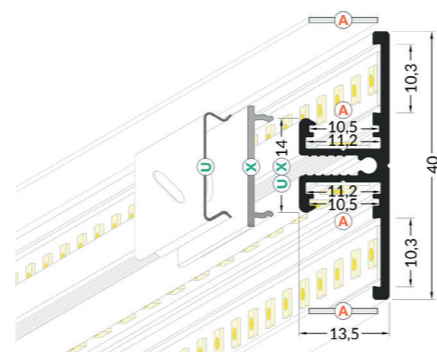

PROFILÉS LED MARCHE-10

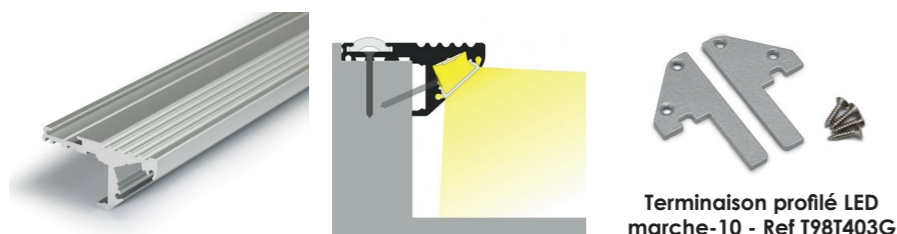

Terminaison profilé LED marche-10 - Ref T98T403G

REF	TAILLE	FINITION	DIFFUSEUR ASSOCIÉ	FIXATION ASSOCIÉE
T98403A1	1000mm	Alu anodisé	C	Vis
T98403A2	2000mm			

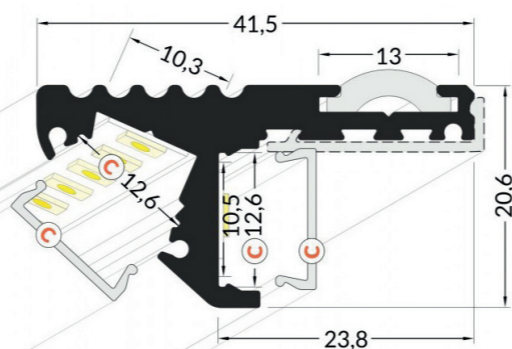

Couvercle Profilés LED Marche-10

REF	LONGUEUR	LARGEUR	FINITION
T98404A1	1000mm	20mm	Alu anodisé
T98404A2	2000mm		

Antidérapant Profilés LED Marche-10

REF	LONGUEUR
T98405A1	1000mm
T98405A2	2000mm

PROFILÉS LED MUR-12



Support profilé LED mur-12

Gris : T98T407G1
Blanc : T98T407B1

Support profilé LED mur-12

Gris : T98T407G2
Blanc : T98T407B2

REF	TAILLE	FINITION	DIFFUSEUR ASSOCIÉ	FIXATION ASSOCIÉE
T98407A1	1000mm	Alu anodisé	B / C / D	Vis
T98407A2	2000mm			

Couvercle Profilés LED Mur-12

REF	LONGUEUR	FINITION
T98408B1	1000mm	Blanc
T98408B2	2000mm	
T98408A1	1000mm	Alu anodisé
T98408A2	2000mm	

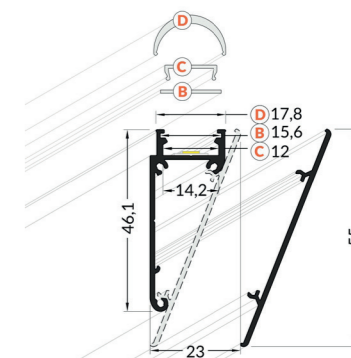

PROFILÉS LED OVALE-20



Support ovale-20 profilé LED - Ref T98S0009

Support ovale-20 profilé LED - Ref T98S0010

REF	TAILLE	FINITION	DIFFUSEUR ASSOCIÉ	FIXATION ASSOCIÉE
T98410A1	1000mm	Alu anodisé	B / C	Support ovale
T98410A2	2000mm			

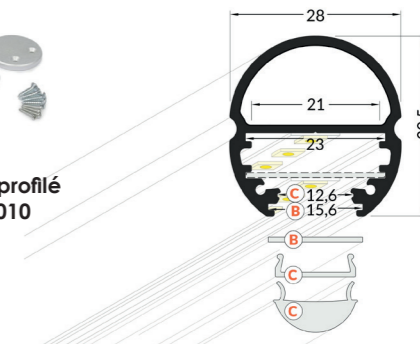

PROFILÉS LED COURBE-12

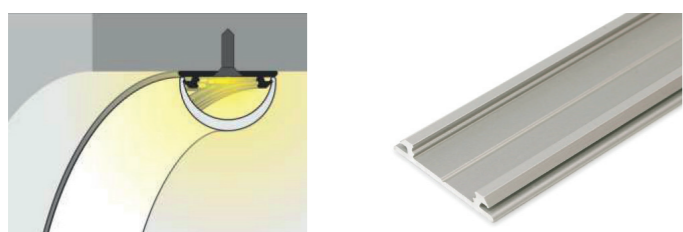

REF	TAILLE	FINITION	DIFFUSEUR ASSOCIÉ	FIXATION ASSOCIÉE
T98406R1	1000mm	Alu brut	C / D	Fixation profilé courbe
T98406R2	2000mm			
T98406A1	1000mm	Alu anodisé		
T98406A2	2000mm			



Terminaison profilé LED courbe-12 (pour diffuseur de type D) Ref T98T406G1

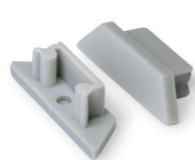

Terminaison profilé LED courbe-12 (pour diffuseur de type C) Ref T98T406G2

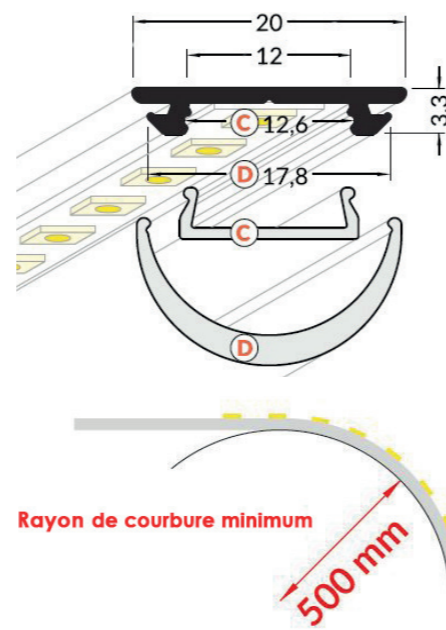

PROFILÉS LED GLASS-10

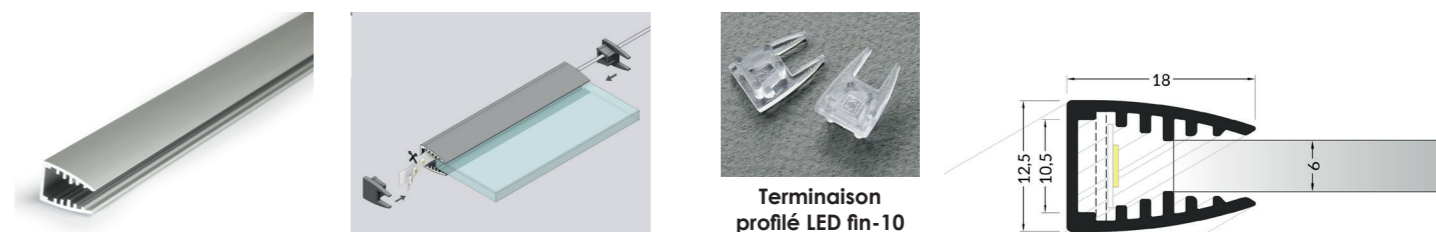

Terminaison profilé LED fin-10 Ref T98T501G

REF	TAILLE	FINITION	FIXATION ASSOCIÉE
T98501A1	1000mm	Alu anodisé	NÉANT
T98501A2	2000mm		

Baguettes pour fonds incluses

PROFILÉS LED BORD-10

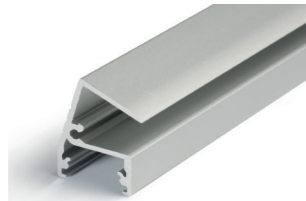

Terminaison profilé LED bord-10
Ref T98T503G

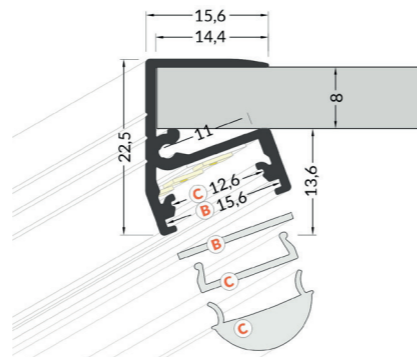

REF	TAILLE	FINITION	DIFFUSEUR ASSOCIÉ	FIXATION ASSOCIÉE
T98503A1	1000mm	Alu anodisé	B / C	NÉANT
T98503A2	2000mm			

PROFILÉS LED GLASS LINE-12

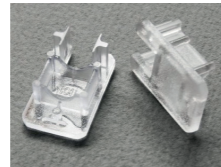
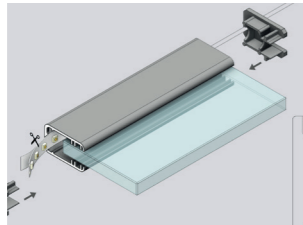
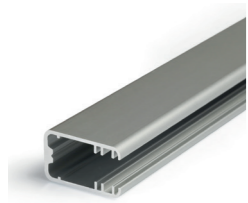

Terminaison profilé LED Glass Line-12
Ref T98T502G

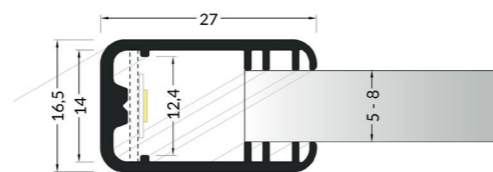

REF	TAILLE	FINITION	FIXATION ASSOCIÉE
T98502A1	1000mm	Alu anodisé	NÉANT
T98502A2	2000mm		

Baguettes pour fonds incluses

*Diffuseurs, supports,
connecteurs et bandes LED*

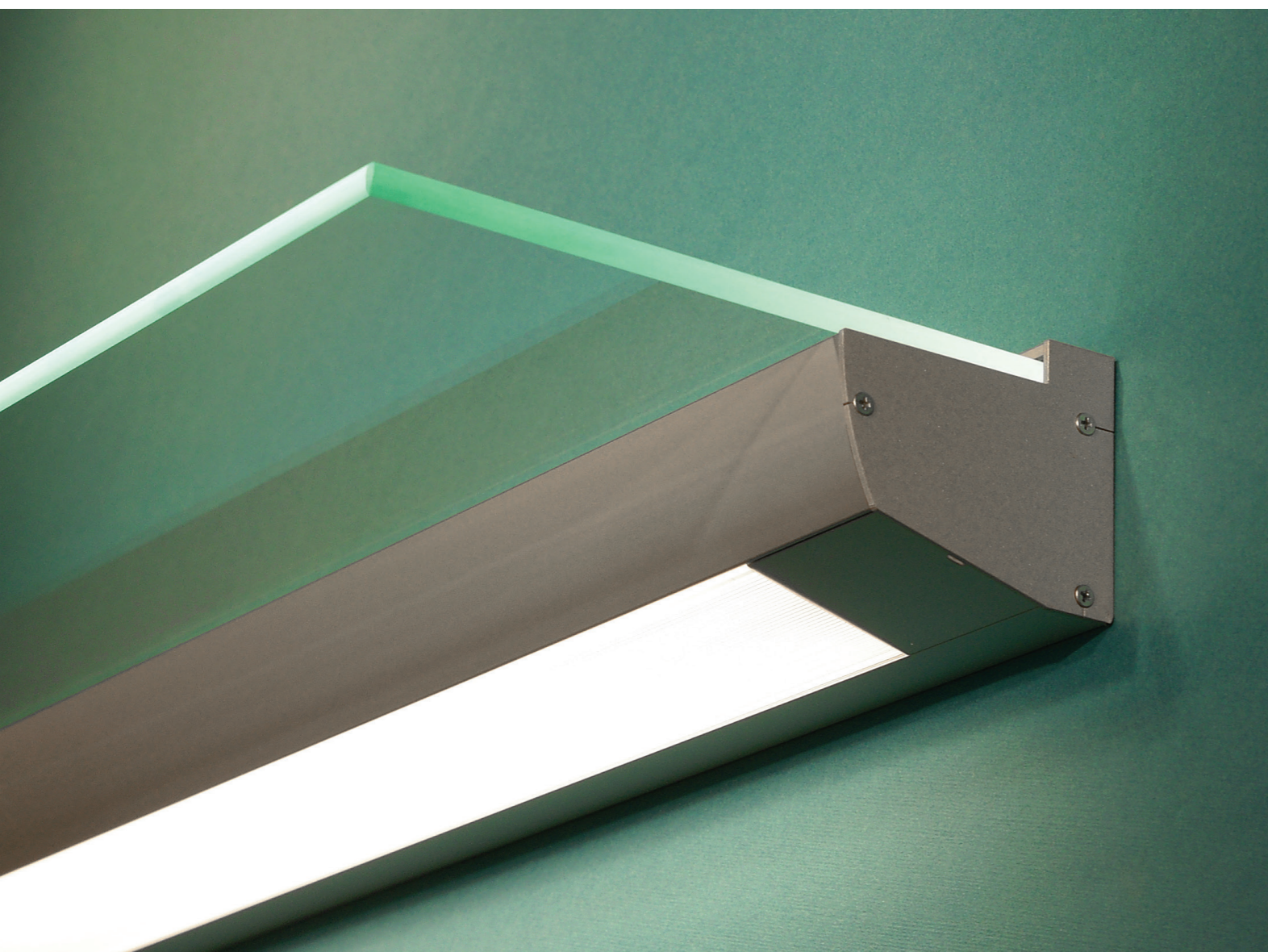

DIFFUSEURS

Diffuseurs Plat

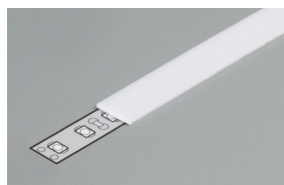

Blanc

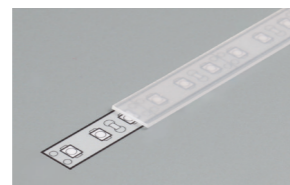

Dépoli

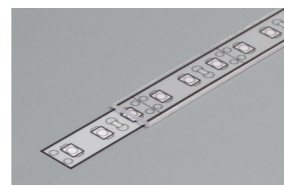

Transparent

REF	TYPE	LONGUEUR	LARGEUR	FINITION
T98901B1	A	1000mm	10,2mm	Blanc
T98901B2		2000mm		
T98901D1		1000mm		Dépoli
T98901D2		2000mm		
T98901T1		1000mm		Transparent
T98901T2		2000mm		

REF	TYPE	LONGUEUR	LARGEUR	FINITION
T98902B1	B	1000mm	15,4mm	Blanc
T98902B2		2000mm		
T98902D1		1000mm		Dépoli
T98902D2		2000mm		
T98902T1		1000mm		Transparent
T98902T2		2000mm		

REF	TYPE	LONGUEUR	LARGEUR	FINITION
T98906B1	E	1000mm	19,2mm	Blanc
T98906B2		2000mm		
T98906D1		1000mm		Dépoli
T98906D2		2000mm		
T98906T1		1000mm		Transparent
T98906T2		2000mm		

REF	TYPE	LONGUEUR	LARGEUR	FINITION
T98909B1	G	1000mm	29,5mm	Blanc
T98909B2		2000mm		
T98909D1		1000mm		Dépoli
T98909D2		2000mm		
T98909T1		1000mm		Transparent
T98909T2		2000mm		

Diffuseurs Clip Arc



REF	TYPE	LONGUEUR	LARGEUR	FINITION
T98905B1	D	1000mm	19,2mm	Blanc
T98905B2		2000mm		

Diffuseurs Reflex



REF	TYPE	LONGUEUR	LARGEUR	FINITION
T98910B1	H	1000mm	35,6mm	Blanc
T98910B2		2000mm		

Diffuseurs Sol

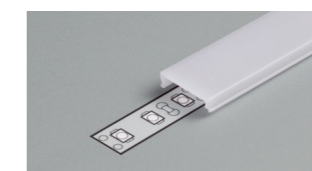

REF	TYPE	LONGUEUR	LARGEUR	FINITION
T98913B1	K	1000mm	15,5mm	Blanc
T98913B2		2000mm		

Diffuseurs Clip

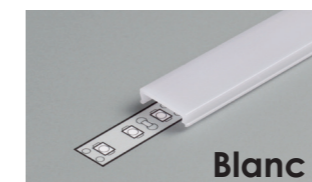

Blanc

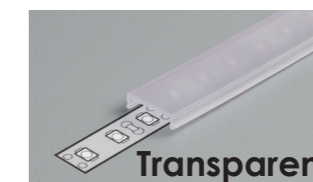

Transparent

REF	TYPE	LONGUEUR	LARGEUR	FINITION
T98903B1	C	1000mm	15,4mm	Blanc
T98903B2		2000mm		
T98903T1		1000mm		Transparent
T98903T2		2000mm		

REF	TYPE	LONGUEUR	LARGEUR	FINITION
T98908B1	F	1000mm	19,2mm	Blanc
T98908B2		2000mm		
T98908T1		1000mm		Transparent
T98908T2		2000mm		

Diffuseurs Lentille

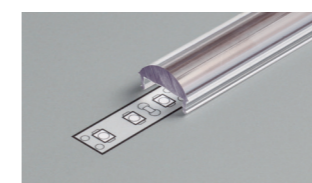

REF	TYPE	LONGUEUR	LARGEUR	FINITION
T98903L1	C	1000mm	15,4mm	Transparent
T98903L2		2000mm		

Diffuseurs Tubes



REF	TYPE	LONGUEUR	LARGEUR	FINITION
T98911B1	I	1000mm	11mm	Blanc
T98911B2		2000mm		
T98911T1		1000mm		Dépoli
T98911T2		2000mm		

SUPPORTS PROFILÉS LED



MODÈLE	TYPE	REF
Souple Cone	U	T98S0003



MODÈLE	TYPE	REF
Souple Cone 14	Y	T98S0006

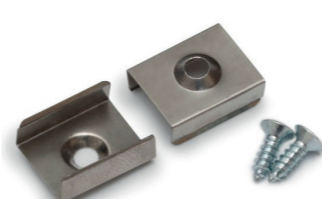

MODÈLE	TYPE	REF
Souple Cone Fin	Z	T98S0004



MODÈLE	TYPE	REF
Souple Cone Courbe	U5	T98S0005

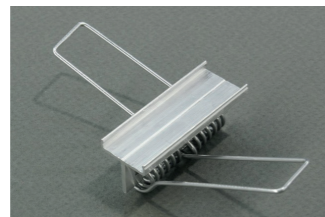

MODÈLE	TYPE	REF
Placo (pour rainure et reflex)	X	T98S0011

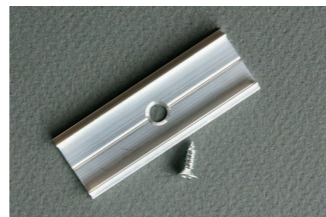

MODÈLE	TYPE	REF
Connecteur	Z	T98S0008



MODÈLE	TYPE	REF
Support	X	T98S0002

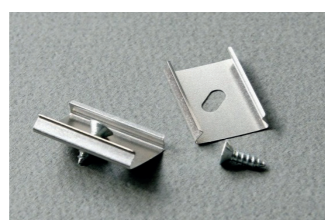

MODÈLE	TYPE	REF
Support	U	T98S0001



MODÈLE	TYPE	REF
Support	W	T98S0007

CONNECTEURS ANGLES

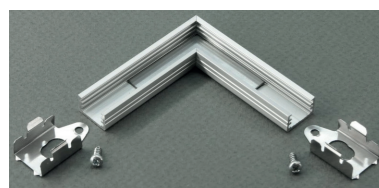

MODÈLE	REF
Fin	T98S0014



MODÈLE	REF
Angle 30/60°	T98S0015



MODÈLE	REF
Rainure	T98S0016



MODÈLE	REF
Plat	T98S0017

BANDES LED TECHLED - GAMME PRO



REF	PUISSANCE/M	LED/M	T° COULEUR	LUMENS/M	IP	LARGEUR	TENSION
T9712081	7,2W	72	3000°K	720 à 840	20	6mm	12V
T9712091			4000°K				
T9712101			6000°K				

Éclairage tangenciel

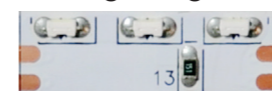

REF	PUISSANCE/M	LED/M	T° COULEUR	LUMENS/M	IP	LARGEUR	TENSION
T97120111	9W	120	8000°K	960	20	8mm	12V

CCT ajustable



REF	PUISSANCE/M	LED/M	T° COULEUR	LUMENS/M	IP	LARGEUR	TENSION
T9712011	18W	120	2700 à 6500°k	1800 à 2000	20	8mm	12V
T9712015					68	10mm	



REF	PUISSANCE/M	LED/M	T° COULEUR	LUMENS/M	IP	LARGEUR	TENSION
T9712021	18W	120	3000°K	1800 à 2000	20	8mm	12V
T9712031			4000°K				
T9712041			6000°K				
T9712025			3000°K		68	10mm	
T9712035			4000°K				
T9712045			6000°K				



REF	PUISSANCE/M	LED/M	T° COULEUR	LUMENS/M	IP	LARGEUR	TENSION
T9712051	24W	240	3000°K	3000	20	10mm	12V
T9712061			4000°K				
T9712071			6000°K				



REF	PUISSANCE/M	LED/M	T° COULEUR	LUMENS/M	IP	LARGEUR	TENSION
T9712015	12W	60	BLEU	2100	68	8mm	12V



REF	PUISSANCE/M	LED/M	T° COULEUR	LUMENS/M	IP	LARGEUR	TENSION
T9712131	14,4W	60	RGB + BLANC de 2700 à 6500°K	600	20	12mm	12V

TECHLED

www.techledfrance.com - 05.81.60.87.84

contact@techledfrance.com